

FCS 40 A

8	Pantolonluk / Trousers
4	Kravattuk / Tie

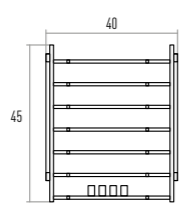

FCS 40 B

7	Pantolonluk / Trousers
4	Kravattuk / Tie

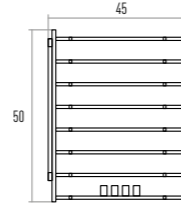

FCS 45 A

8	Pantolonluk / Trousers
4	Kravattuk / Tie

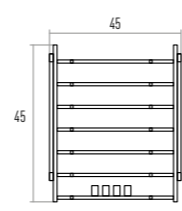

FCS 45 B

7	Pantolonluk / Trousers
4	Kravattuk / Tie

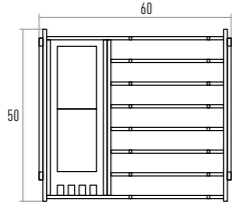

FCS 60 A

8	Pantolonluk / Trousers
1	Sepet / Basket
4	Kravattuk / Tie

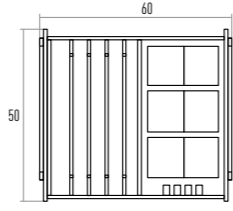

FCS 60 B

4	Pantolonluk / Trousers
3	Sepet / Basket
4	Kravattuk / Tie

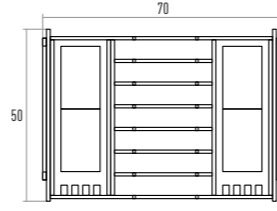

FCS 70 A

8	Pantolonluk / Trousers
2	Sepet / Basket
8	Kravattuk / Tie

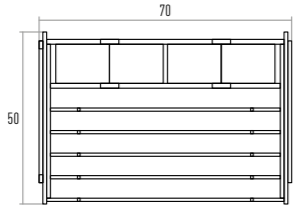

FCS 70 B

5	Pantolonluk / Trousers
2	Sepet / Basket

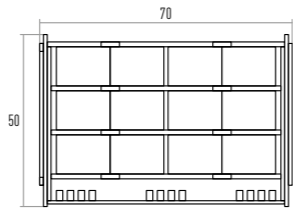

FCS 70 C

6	Sepet / Basket
12	Kravattuk / Tie

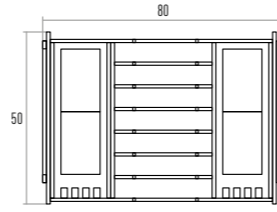

FCS 80 A

8	Pantolonluk / Trousers
2	Sepet / Basket
8	Kravattuk / Tie

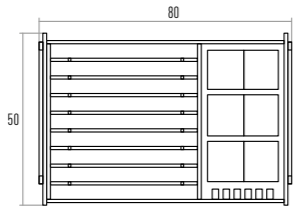

FCS 80 B

8	Pantolonluk / Trousers
3	Sepet / Basket
6	Kravattuk / Tie

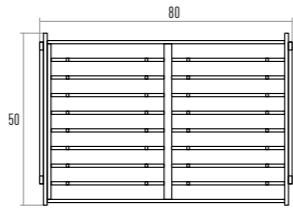

FCS 80 C

16	Pantolonluk / Trousers
----	------------------------

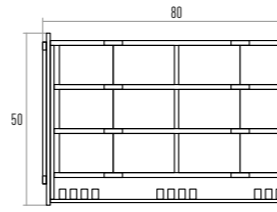

FCS 80 D

6	Sepet / Basket
9	Kravattuk / Tie

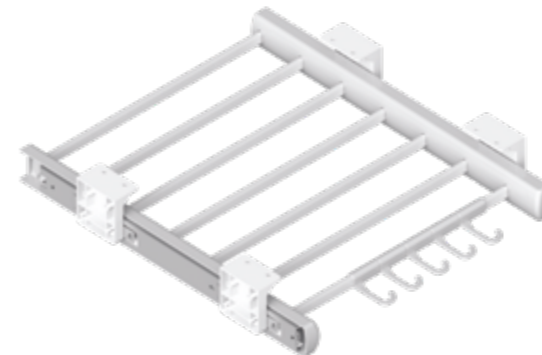
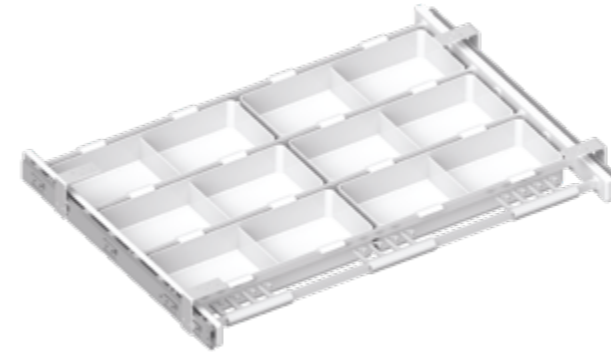
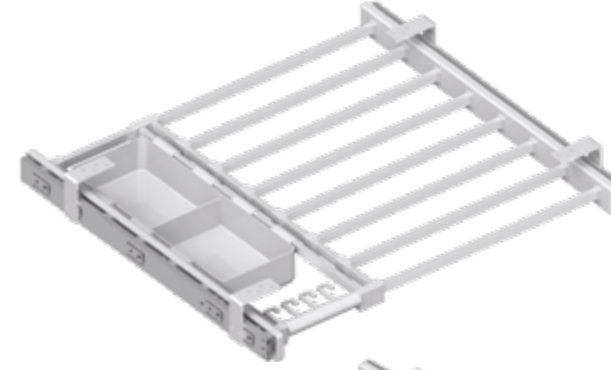

40x45 cm

EKO PANTOLONLUK
ECO TROUSER

7	Pantolonluk / Trousers
5	Kravattuk / Tie

